

Table of Contents English

Chapter 1: Safety Information.....	1
Handling Safety	1
Electrical Safety.....	1
Deenergizing Safety	1
Battery Safety	2
Replacement and Recycling of Batteries	2
Chapter 2: Basics.....	3
About Your New UPS	3
Limited Warranty	3
How to Contact APC	4
Latin America, South America	4
Europe, Middle East, Africa	4
Asia, Australia.....	4
Chapter 3: Installing Your Smart-UPS.....	5
Unpacking.....	5
Inspection.....	5
Contents	5
Placement.....	5
How to Install Your Smart-UPS	5
Chapter 4: Operating the Smart-UPS.....	11
Indicators and Controls.....	11
Front Panel.....	11
Rear Panel	14
On-Battery Operation	15
How to Determine On-Battery Run Time	15
User Configuration Items	16
Chapter 5: Maintenance and Troubleshooting.....	17
Storage.....	17
Storage Conditions.....	17
Extended Storage	17
Replacing the Battery	17
Battery Replacement Procedure.....	17
Troubleshooting.....	19
Service	20

Appendix A: Specifications	21
Regulatory Agency Approvals	22
Declaration of Conformity	22
Appendix B: Transporting the UPS.....	23

CHAPTER 1: SAFETY INFORMATION

This Safety Guide contains important instructions that should be followed during installation and maintenance of the APC equipment and batteries. It is intended for APC customers who setup, install, relocate, or maintain APC equipment.

Handling Safety

- Be careful. Do not lift heavy loads without assistance.

<18 kg (<40 lb.)



18 - 32 kg (40 - 70 lb.)





- This equipment is intended for installation in a temperature-controlled indoor area (see *Appendix A: Specifications*, page 21, for exact temperature range), free of conductive contaminants.

Electrical Safety

- Do not work alone under hazardous conditions.
- High short circuit current through conductive materials could cause severe burns.
- A licensed electrician is required to install permanently wired equipment.
- Check that the power cord(s), plug(s), and sockets are in good condition.
- To reduce the risk of electric shock when grounding cannot be verified, disconnect the equipment from the AC power outlet before installing or connecting to other equipment. Reconnect the power cord only after all connections are made.
- Do not handle any kind of metallic connector before the power has been removed.
- Use one hand, whenever possible, to connect or disconnect signal cables to avoid a possible shock from touching two surfaces with different electrical grounds.
- Connect the equipment to a three wire AC outlet (two poles plus ground). The receptacle must be connected to appropriate branch circuit/mains protection (fuse or circuit breaker). Connection to any other type of receptacle may result in a shock hazard.

Deenergizing Safety

- If the equipment has an internal energy source (the battery), the output may be energized when the unit is not connected to an AC power outlet.
- To deenergize **pluggable equipment**: first press the Off button for more than one second to switch the equipment off. Next disconnect the equipment from the AC power outlet. Finally, disconnect the battery.

- To deenergize **permanently wired** equipment: set the power switch to standby . Next set the AC circuit breaker to standby . Then disconnect the batteries (including any expansion units). Finally, disconnect the AC power from the building power supply.
- Pluggable equipment includes a protective earth conductor which carries the leakage current from the load devices (computer equipment). Total leakage current must not exceed 3.5 mA.
- Use of this equipment in life support applications where failure of this equipment can reasonably be expected to cause the failure of the life support equipment or to significantly effect its safety or effectiveness is not recommended.

Battery Safety

- This equipment contains potentially hazardous voltages. Do not attempt to disassemble the unit. The only exception is for equipment containing batteries. Battery replacement using the procedures below is permissible. Except for the battery, the unit contains no user serviceable parts. Repairs are performed only by factory trained service personnel.
- Do not dispose of batteries in a fire. The batteries may explode.
- Do not open or mutilate batteries. They contain an electrolyte which is toxic and harmful to the skin and eyes.
- To avoid personal injury due to energy hazard, remove wrist watches and jewelry such as rings when replacing the batteries. Use tools with insulated handles.
- Replace batteries with the same number and type of batteries as originally installed in the equipment.

Replacement and Recycling of Batteries

See your dealer or *Replacing the Battery*, page 17, for information on replacement battery kits and battery recycling.

About Your New UPS

This APC Uninterruptible Power Supply (UPS) is designed to prevent blackouts, brownouts, sags and surges from reaching your computer and other valuable electronic equipment. This UPS also filters out small utility line fluctuations and isolates your equipment from large disturbances by internally disconnecting from the utility line, while supplying power from its internal batteries until the utility line returns to safe levels.

The UPS is ready to be mounted in a 19-inch wide EIA/IEC rack cabinet.

Limited Warranty

American Power Conversion (APC) warrants its products to be free from defects in materials and workmanship for a period of two years from the date of purchase. Its obligation under this warranty is limited to repairing or replacing, at its own sole option, any such defective products. To obtain service under warranty you must obtain a Returned Material Authorization (RMA) number from customer support (see *Service*, page 20). Products must be returned with transportation charges prepaid and must be accompanied by a brief description of the problem encountered and proof of date and place of purchase. This warranty does not apply to equipment which has been damaged by accident, negligence, or misapplication or has been altered or modified in any way. This warranty applies only to the original purchaser who must have properly registered the product within 10 days of purchase.

EXCEPT AS PROVIDED HEREIN, AMERICAN POWER CONVERSION MAKES NO WARRANTIES, EXPRESSED OR IMPLIED, INCLUDING WARRANTIES OF MERCHANTABILITY AND FITNESS FOR A PARTICULAR PURPOSE. Some states do not permit limitation or exclusion of implied warranties; therefore, the aforesaid limitation(s) or exclusion(s) may not apply to the purchaser.

EXCEPT AS PROVIDED ABOVE, IN NO EVENT WILL APC BE LIABLE FOR DIRECT, INDIRECT, SPECIAL, INCIDENTAL, OR CONSEQUENTIAL DAMAGES ARISING OUT OF THE USE OF THIS PRODUCT, EVEN IF ADVISED OF THE POSSIBILITY OF SUCH DAMAGE. Specifically, APC is not liable for any costs, such as lost profits or revenue, loss of equipment, loss of use of equipment, loss of software, loss of data, costs of substitutes, claims by third parties, or otherwise.

How to Contact APC

Internet <http://www.apcc.com>

Latin America, South America

Argentina.....0800.9.APCC (0800.9.2722)	Mexico95.800.804.4283
Brazil.....0800.12.72.21	Uruguay.....000.413.598.2139
Colombia.....980.15.39.47	Venezuela.....8001.2856
Emailapctchla@apcc.com	

Europe, Middle East, Africa

Phone.....+353 91 702020	Email Europe.....apceurtech @ apcc.com
Fax.....+353 91 755275	Email Central Africaresl afr@apcc.com
Ireland1 800 702000 x 2045	Luxembourg....0800 2091
Austria.....0660 6480	Norway800 11 632
Belgium.....0800 15063	Poland00800 353 1202
Denmark.....800 18 153	Portugal.....0800 853 182
France.....0800 906 483	Russia.....007 095 2306297 (toll number)
Finland9800 13 374	South Africa....0800 994206
Germany.....0800 180 1227	Spain900 95 35 33
Holland.....0800 0224655	Sweden.....020 795 419
Hungary.....00800 12221	Switzerland0800 556177
Israel.....177 353 2206	Turkey.....0800 35390275
Italy1678 74731	UK0800 132990

Asia, Australia

Australia, New Zealand.....	+61 2 9955 9366, 1-800-652-725
Singapore, Thailand, Vietnam.....	+65 337 4462
Malaysia.....	+60 3 756 8786
Indonesia.....	+62 21 6500813
China.....	+86 10 6201 6688
Hong Kong, Taiwan.....	+88 622 755 1945
India, Nepal, Sri Lanka, Bangladesh, Maldives.....	+91 44 433 1124
Korea.....	+82 2 501 6492
Philippines.....	+63 2 813 2662
Email for Southeast Asia.....	asetech@apcc.com
Email for Australia.....	anztech@apcc.com
Email for India.....	isbtech@apcc.com

CHAPTER 3: INSTALLING YOUR SMART-UPS

Unpacking

APC has taken care to design robust packaging for your product. However, accidents and damage may occur during shipment.

Inspection

Inspect the UPS upon receipt. Notify the carrier and dealer if there is damage. The packaging is recyclable; save it for reuse or dispose of it properly.

Contents

The shipping package contains the UPS, its front panel bezel (disconnected from the unit), 1U mounting rails, and a literature kit (containing software, mounting hardware, two serial cables, and product documentation).

Placement

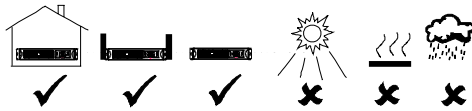

Install the UPS in a protected area that is free of excessive dust and has adequate air flow. Do not operate the UPS where the temperature and humidity are outside the specified limits.



Changes or modifications to this unit not expressly approved by the party responsible for compliance could void the warranty.

How to Install Your Smart-UPS

To install the UPS follow these five steps:

1. Mount the UPS in the rack.
2. Connect the battery and attach the front panel bezel.
3. Connect power and the equipment to the UPS.
4. Turn on the UPS.
5. Install PowerChute® software (optional) and accessories.

This section describes each step in detail.

Install the UPS in the Rack



The UPS requires two people to install due to its weight.

To lighten the UPS, you may remove the batteries while you mount the unit in the rack. Refer to **Replacing the Battery**, page 17, for instructions on removing the batteries.

Please observe the following guidelines when installing the UPS:

- The UPS comes with standard 19" (46.5 cm) rack mount brackets (ears) installed.
- The UPS can be mounted in either a 2-post or 4-post rack. You may need to reposition the rack mount brackets for some installations, such as a 2-post rack installation. The rack can have any of the common types of equipment mounting holes (square, round-threaded, or round-non-threaded). All necessary hardware is provided.
- Two additional sets of bracket holes, shown in the following figure, are located on the sides of the UPS. These holes allow you to mount the brackets with a 1.4 inch or 5 inch setback. Move the rack mount brackets back, if desired, to optimize the esthetic or physical requirements of the rack.

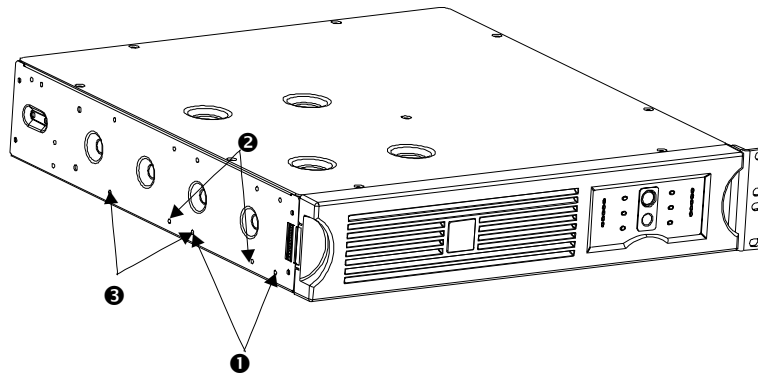

Note: Left mounting bracket removed for clarity.

- Where
- ❶ = Standard ear mounting location
 - ❷ = Optional (1.4 inch setback) ear mounting location
 - ❸ = 2-post rack (5 inch setback) ear mounting location

- Optional 24" rack mount brackets are available (part number SU026-2U).
- Mounting rails are included. The rails support the UPS and allow adequate air flow.

Mount the UPS in the Rack



- The mounting rails are designed to fit a four-post rack. If you are using a two-post rack, use the mounting brackets alone to mount the UPS.
- If you are using a two-post rack, you should reposition the mounting brackets to the 5" setback position before mounting the UPS in your rack.
- Due to the weight of the UPS, two people are required to mount the UPS in a rack.



Check the rack to make sure it will not tip after moving the UPS mounting brackets.

1. Select a location for the UPS in your rack. Mount the UPS at or near the bottom of the rack. The UPS occupies a space of 2U. Some racks have tick marks to indicate the U-spaces.
 - UPSs are heavy. Select a rack location sturdy enough to handle the weight.
 - Select a rack location with adequate air flow that is free from excessive dust. Ensure that the air vents on the sides of the UPS are not blocked. Do not operate the UPS where temperature or humidity are outside the limits listed in *Appendix A: Specifications*, page 21.
2. Use the nut plate provided (part number 870-1148) to identify the correct holes where the mounting bracket will attach. The top and bottom holes on the nut plate align with the top and bottom holes on the mounting brackets.

For racks with square holes: Use the square button to locate the mounting position.

For racks with round holes: Use the round button to locate the mounting position.

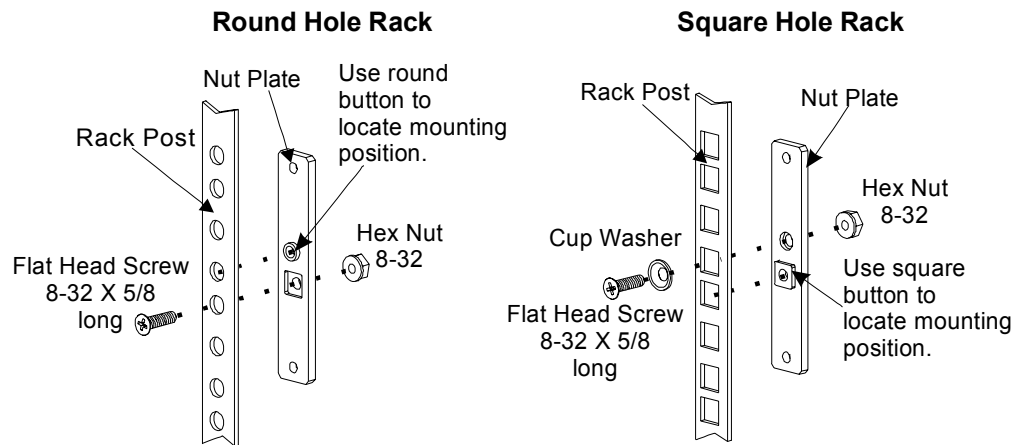

3. Locate the 1U mounting rails and remove the slide screw and nut, shown at ❶. Leave the front ❷ and rear ❸ segments, assembled.



4. The sides of the UPS have two holes at the rear of the unit. Align the top two holes on the front rail segment ❷, with the two holes at the rear of the UPS and secure them with the flat head screws (#8 x 1/4"), provided.

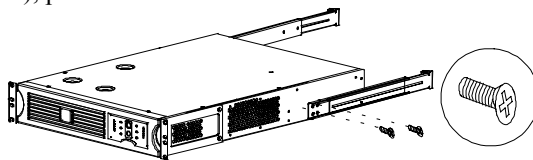

Two people are required to complete this step due to the weight of the UPS.

5. Support the UPS from the bottom or rear of the unit and slide it into the rack.

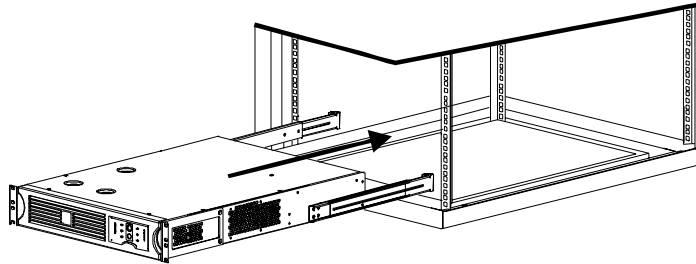

6. Secure the UPS into position by inserting two ornamental (10-32) screws through the front of the mounting bracket on each side. The screws will thread into the nut plate.

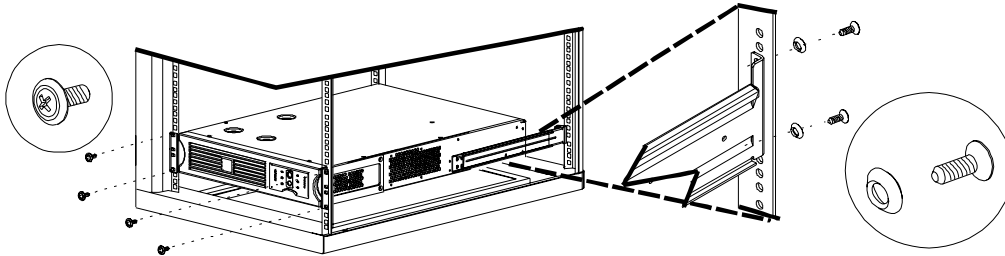

7. From the rear of the rack, extend the rear rail segment to the rear rack post. Use the (flat head screws #10 x 1/2") and cup washers provided, to attach the rail to the rack post.

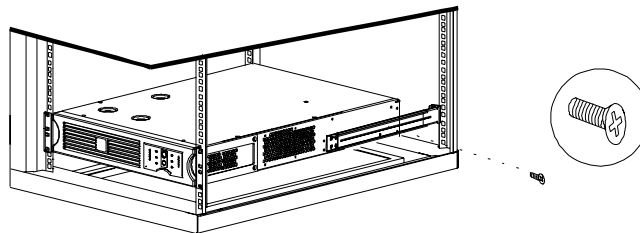

8. Insert and tighten the slide screws and nuts to secure the front and rear rail segments.

Removing the UPS from the Rack

1. Remove the front panel bezel: Face the front of the UPS, and, using both hands, insert each index finger behind the lip of the curved section of the front panel bezel and pull towards you.
2. From the rear of the rack, remove the slide screws and nuts that connect the rails segments.
3. Support the UPS from the bottom or rear of the unit.
4. Grasp the battery tray handle to support the front of the unit.
5. Remove the four ornamental screws (two screws on each mounting bracket).
6. Slide the UPS out of the rack.

Connect the Battery and Attach the Front Panel Bezel



The UPS is shipped without its battery connected and the front panel bezel installed (it is packaged separately within the main box). You must connect the battery and install the plastic front panel bezel before the installation is complete.

1. Facing the front of the UPS, locate the battery cable (in the center of the unit) and remove the tape to expose the cable connector.
2. Locate the UPS battery connector ❶ which is to the right of the battery tray ❷ and recessed. Connect the battery cable connector to the UPS connector. Press firmly to ensure that the connection is tight. You will hear a “snap” when the connector is properly seated. Also, as a visual indication, the back of the connector should be recessed (0.25 in.) from the sheet metal on the front of the unit. You may see small sparks when connecting the battery.

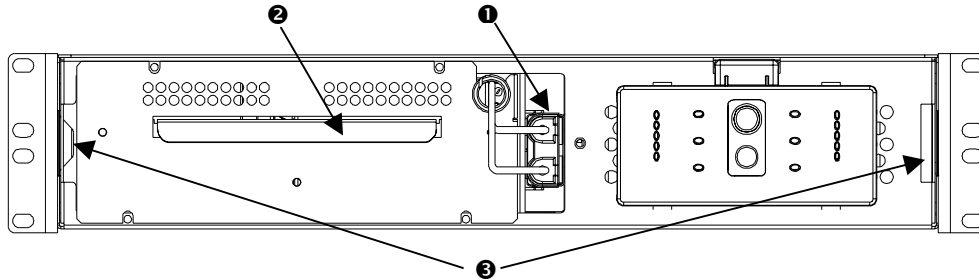

3. Tuck the white battery cable cord into the space above the UPS connector.
4. Unpack the front panel bezel and hold it with the cutout section on the right. Align the tabs on the side of the bezel with the slots on the front of the UPS ❸ and firmly snap it into place.

Connect Power and Equipment to the UPS



Use an APC supplied cable to connect to the Computer Interface Port. DO NOT use a standard serial interface cable since it is incompatible with the UPS connector.

The UPS package contains two serial cables. Refer to the *Software Installation Instruction Sheet*, included with the UPS, to determine which serial cable to use.

- Plug the UPS into a standard receptacle.
- Plug the equipment into the back of the UPS.
- Do not plug laser printers into a UPS of 1000 VA or less, due to the large increase in power consumption when printing.
- Turn on all connected equipment (the equipment will not be powered until the UPS is turned on).
- Add accessories for the SmartSlot. See the literature accompanying the accessory for details.

- Connect ground leads to the TVSS screw (optional). The transient voltage surge suppression (TVSS) screw provides grounding through the UPS's power cord ground conductor. See **Rear Panel**, page 14, for the location of the screw. To make the connection, loosen the screw and connect the surge suppression device's ground lead. Tighten the screw to secure the lead.

Turn on the UPS



Make sure the battery is connected before turning on the UPS!

- Press the UPS's on  button, located on the front panel, to power-up your UPS. This will power-up connected equipment.
-



The UPS charges its battery whenever it is connected to utility power. The battery charges fully during the first four hours of normal operation. **Do not** expect full run time during this initial charge period.

- The unit performs a self-test automatically when turned on, and every two weeks thereafter (by default).

Install PowerChute Software (Optional)

For additional computer system security, install PowerChute UPS monitoring software. It provides automatic unattended shutdown capabilities on most major network operating systems. See the **Software Installation Instruction Sheet** included with the UPS, for details.



This UPS is equipped with a SmartSlot for accessories. See the APC website (apcc.com) for available accessories.

If a standard accessory is installed on this UPS, follow the installation instructions for the accessory, which are included in the package.

CHAPTER 4: OPERATING THE SMART-UPS

Indicators and Controls

This rack mount UPS has the power control and operating indicators located on the front panel. The rear panel has the input and output connectors.

Front Panel

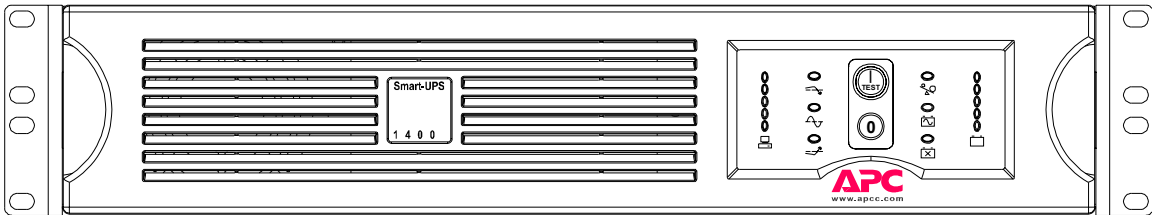

Switch On – Switch Off



To turn the UPS on: With the UPS plugged in, press and release the large, upper button labeled “TEST” to supply power to the connected equipment. The equipment is immediately powered while the UPS performs a self-test.



To turn the UPS off: Press and release the small, lower button labeled “0” to turn off power to the connected equipment. It may be convenient to use the UPS as a master on/off switch for the connected equipment.



Whenever the UPS is plugged in and utility voltage is present, the charger maintains battery charge.

On-line Indicator



The on-line indicator illuminates when the UPS is supplying utility power to the connected equipment.

Load Bar Graph

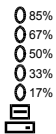

The 5-LED display on the left of the front panel represents the power drawn from the UPS as a percentage of total capacity. For example, if three LEDs are lit, the load (connected equipment) is drawing between 50% and 67% of the UPS’s capacity. If all five LEDs light, thoroughly test your complete system to make sure that the UPS will not become overloaded. In the graphic to the left, the load capacity threshold is listed next to the LED (these are not shown on the actual UPS).

On-Battery Indicator



During on-battery operation, the on-battery LED illuminates and the UPS sounds an audible alarm consisting of four beeps every 30 seconds. The alarm stops when the UPS returns to on-line operation. Refer to **On-Battery Operation**, page 15, for details.

Battery Charge Bar Graph

- 96%
- 72%
- 48%
- 24%
- 0%

The 5-LED display on the right of the front panel shows the present charge of the UPS's battery as a percentage of the battery's capacity. When all five LEDs are lit, the battery is fully charged.

The LEDs extinguish, from top to bottom, as the battery capacity diminishes. The battery capacity threshold is shown in the figure to the left (it is not listed on the front panel display).



As a low battery warning, any LEDs illuminated (for the given capacity) will flash. The low battery warning setting can be changed from the rear panel (see *Low Battery Warning Level*, page 14) or through the PowerChute software.

Overload



When the UPS is overloaded (when the connected equipment exceeds the maximum specified in the "maximum load," section in *Appendix A: Specifications*, page 21), the overload LED comes on and the UPS emits a sustained tone. The alarm remains on until the overload is removed. The UPS continues to supply power as long as it is on line and the breaker does not trip, but it will not provide power from batteries in the event of a utility voltage interruption. Disconnect nonessential equipment from the UPS to eliminate the overload. If a continuous overload occurs while the UPS is on battery, the UPS will turn off its output in order to protect itself from possible damage.

Self-Test

The UPS performs a self-test automatically when turned on, and every two weeks thereafter (by default). Automatic self-test eases maintenance requirements by eliminating the need for periodic manual self-tests. During the self-test, the UPS briefly operates the connected equipment on-battery. If the UPS passes the self-test, it returns to on-line operation.



If the UPS fails the self-test it immediately returns to on-line operation and lights the replace battery LED. The connected equipment is not affected by a failed test. Recharge the battery for 24 hours and perform another self-test. If it fails, the battery must be replaced. See *Replacing the Battery*, page 17, for details.

How to Manually Initiate a Self-Test

Press and hold the on button (on the front panel) for a few seconds before the self-test will begin.

Replace Battery



If the battery fails a self-test, the UPS emits short beeps for one minute and the replace battery LED illuminates. (If the LED flashes, the battery is disconnected.) The UPS repeats the alarm every five hours. Perform the self-test procedure after the battery has charged for 24 hours to confirm the replace battery condition. The alarm will stop if the battery passes the self-test.

Voltage Trim



The voltage trim LED comes on to indicate that the UPS is compensating for a high utility voltage.

Voltage Boost



The voltage boost LED comes on to indicate that the UPS is compensating for a low utility voltage.

Low Battery

When the UPS is operating on-battery and the energy reserve of the battery runs low, the UPS beeps continuously (by default) until the UPS shuts down from battery exhaustion or returns to on-line operation. The low battery warning interval can be changed through software.

Cold Start

When the UPS is off and there is no utility power, use the cold start feature to apply power to the connected equipment from the UPS's battery. **Cold start is not a normal condition.**

- Press and hold the on button until the UPS beeps.
- Release the on button during the beep and the connected equipment is powered.

Utility Voltage Bar Graph

- 266
- 248
- 229
- 210
- 192



This UPS has a diagnostic feature that displays the utility voltage. With the UPS plugged into the normal utility power, press and hold the on button to see the utility voltage bar graph display. After a few seconds the 5-LED display on the right of the front panel shows the utility input voltage. Refer to the figure to the left for the voltage reading (values are not listed on the UPS).

The display indicates that the voltage is between the displayed value from the list and the next higher value. For example, with three LEDs lit, the input voltage is between 229 and 248 VAC.

If no LEDs come on and the UPS is plugged into a working AC power outlet, the line voltage is extremely low.

If all five LEDs come on, the line voltage is extremely high and should be checked by an electrician.



The UPS starts a self-test as part of this procedure. The self-test does not affect the voltage display.

Shutdown Mode (via software or an accessory)

In shutdown mode the UPS stops supplying power to the connected equipment, waiting for the return of utility power. If there is no utility power present, external devices (e.g., servers) connected to the computer interface or the accessory slot can command the UPS to shut down. This is normally done to preserve battery capacity after the graceful shutdown of protected servers. The UPS will scroll the front panel indicators sequentially in shutdown mode.

Rear Panel

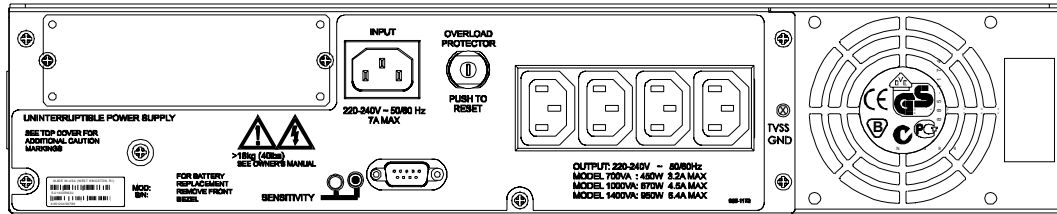

Computer Interface Port

-  Power management software and interface kits can be used with this UPS. **Use only interface kits supplied or approved by APC.** If used, connect the interface cable to the 9-pin computer interface port on the back panel of the UPS. Secure the connector's screws to complete the connection.

TVSS Screw

- ⊗ The UPS features a transient voltage surge-suppression (TVSS) screw for connecting the ground lead on surge suppression devices such as telephone and network line protectors. Refer to *Connect Power and Equipment to the UPS*, page 9, for information.

Voltage Sensitivity

- The UPS detects line voltage distortions such as spikes, notches, dips, and swells, as well as distortions caused by operation with inexpensive fuel-powered generators. By default, the UPS reacts to distortions by transferring to on-battery operation to protect the connected equipment. Where power quality is poor, the UPS may frequently transfer to on-battery operation. If the connected equipment can operate normally under such conditions, battery capacity and service life may be conserved by reducing the sensitivity of the UPS.

To reduce UPS sensitivity, press the Sensitivity button on the rear panel. Use a pointed object such as a pen to press the button. Press it once to set the UPS's sensitivity to **reduced**. Press it again to set the sensitivity to **low**. Press the button a third time to reset **normal** sensitivity. The Sensitivity can also be changed through software.

- ☀ normal When the UPS is set to normal sensitivity, the LED is brightly lit.
- ◑ reduced When it is set to reduced sensitivity, the LED is dimly lit.
- low When it is set to low sensitivity, the LED is off.

Low Battery Warning Level

By default, the low battery warning occurs when there are approximately two minutes of on-battery run time remaining. This may not be enough time to gracefully shut down some protected computer systems.

To change the warning interval, press the rear panel Sensitivity button while pressing and holding the front-panel on button.

- ☀ 2 min. When the LED is brightly lit, the low battery warning interval is approximately two minutes.
- ◑ 5 min. When the LED is dimly lit, the low battery warning interval is approximately five minutes.
- 7 min. When the LED is off, the low battery warning interval is approximately seven minutes.

On-Battery Operation

The Smart-UPS will switch to battery operation automatically should the utility power fail. While running on battery, an internal alarm will sound (periodic beeps). Press the on button, on the front panel, to silence the UPS alarm (for the current alarm only). The PowerChute software allows you to change the audible indicator.

If the utility power does not return, the UPS will continue supplying power to the connected equipment until exhausted. A continuous beeping will sound approximately two minutes before the UPS's final low battery shutdown. If using a computer, you must manually save your files and power down before the UPS turns itself off, unless you are using PowerChute interface software that provides automatic, unattended shutdown.

How to Determine On-Battery Run Time



UPS battery life differs based on usage and environment.

On-Battery Run Time (Minutes)				
Load (VA)	Load (watts)	SU700	SU1000	SU1400
50	30	142	224	269
100	60	76	127	157
200	122	37	64	80
300	185	23	41	51
400	249	16	29	37
500	315	12	23	28
600	382	10	18	22
700	450	8.0	15	18
800	522	–	12	15
900	595	–	11	13
1000	670	–	9.2	11
1200	809	–	–	9.0
1400	950	–	–	7.4

User Configuration Items

Note: Setting these items requires software or optional hardware.			
Function	Factory Default	User Selectable Choices	Description
Automatic Self-Test	Every 14 days (336 hours)	Every 7 days (168 hours), On Startup Only, No Self-Test	Sets the interval at which the UPS will execute a self-test. Refer to your software manual for details.
UPS ID	UPS_IDEN	Up to eight characters to define the UPS.	Use this field to uniquely identify the UPS for network management purposes.
Date of Last Battery Replacement	Manufacture Date	Date of Battery Replacement	Reset this date when you replace the battery tray.
Minimum Capacity Before Return from Shutdown	0 percent	15, 25, 35, 50, 60, 75, 90 percent	The UPS will charge its batteries to the specified percentage before return from a shutdown.
Sensitivity	Normal	Reduced, Low	Set lower than normal sensitivity to avoid lowered battery capacity and service life in situations where the connected equipment can tolerate minor power disturbances.
Duration of Low Battery Warning	2 minutes	5, 7, 10, 12, 15, 18, 20 minutes	Sets the time before shutdown at which the UPS issues a low battery warning. Set it higher than the default if the OS needs more time for a graceful shutdown.
Alarm Delay After Line Fail	5 second delay	30 second delay, At Low Battery Condition, No Alarm	To avoid alarms for minor power glitches, set the alarm delay.
Shutdown Delay	20 seconds	0, 60, 120, 240, 480, 720, 960 seconds	Sets the interval between when the UPS receives a shutdown command and when shutdown occurs.
Synchronized Turn-on Delay	0 seconds	20, 60, 120, 240, 480, 720, 960 seconds	The UPS will wait the specified time after the return of utility power before turn-on; for example, to avoid branch circuit overload.
High Transfer Point	253 VAC	257, 261, 265 VAC	To avoid unnecessary battery usage, set the High Transfer Point higher if the utility voltage is chronically high and the connected equipment is known to work under this condition.
Low Transfer Point	208 VAC	204, 200, 196 VAC	Set the Low Transfer Point lower if the utility voltage is chronically low and the connected equipment can tolerate this condition.

CHAPTER 5: MAINTENANCE AND TROUBLESHOOTING

Storage

Storage Conditions

Store the UPS covered and flat (rack mount orientation) in a cool, dry location, with its battery fully charged. Disconnect any cables connected to the computer interface port to avoid unnecessarily draining the battery. See *Removing the UPS from the Rack*, page 8, for instructions.

Extended Storage

At -15 to +30 °C (+5 to +86 °F), charge the UPS's battery every six months.

At +30 to +45 °C (+86 to +113 °F), charge the UPS's battery every three months.

Replacing the Battery

This UPS has an easy to replace hot-swappable battery tray. Battery replacement is a safe procedure, isolated from electrical hazards. You may leave the UPS and the protected equipment on for the following procedure. See your dealer or APC (refer to *How to Contact APC*, page 4) for information on replacement battery cartridges.

Smart-UPS Model	Replacement Battery Cartridge
SU700RM2U	RBC22
SU1000RM2U	RBC23
SU1400RM2U	RBC24



Please read *Chapter 1: Safety Information*, page 1, before replacing the battery tray. Once the battery is disconnected, the connected equipment is not protected from power outages.

Battery Replacement Procedure



1. The battery tray is accessible from the front of the UPS.
 2. Be careful removing the battery tray – it is heavy.
 3. This procedure requires a Phillips head screwdriver.
 4. Small sparks at the battery connectors are normal during re-connection.
-

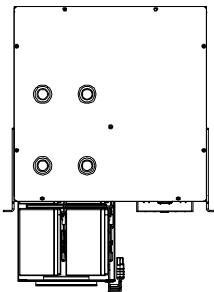
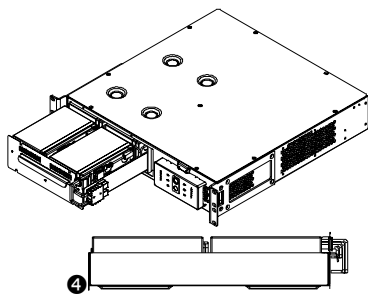
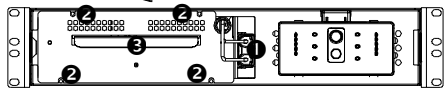
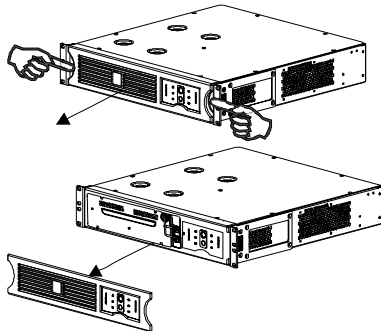

1. Face the front of the UPS and, using both hands, insert each index finger behind the lip of the curved section of the front panel bezel and pull towards you. The front panel bezel will unsnap.
2. Set the bezel aside.
3. Take out the white cord, which is tucked into the space above the battery connector ❶. Grasp the cord and pull firmly towards you to disconnect the battery.
4. Use a Phillips head screwdriver to remove the four (4) screws ❷ that secure the battery tray. Set the screws aside.
5. Use the battery tray handle ❸ to slide the tray out halfway. Then hold the tray from the sides and slide it out to the maximum extended position. A stop tab ❹ on the bottom of the tray will prevent the tray from coming out completely.
6. Carefully lift the tray up so that the stop tab ❹ clears the ledge on the unit.
7. Return the battery tray to APC using the package in which your replacement tray shipped . (See *How to Contact APC*, page 4, for details.) The battery replacement kit includes a new battery tray.
8. Hold the new tray on the sides and align it with the opening.
9. Raise the back of the tray up slightly to position the stop tab on the inside of the opening. Then level the tray and push it in completely.
10. Remove the tape on the new battery tray connector to expose the cable connector.
11. Locate the UPS battery connector ❶ which is to the right of the battery tray and recessed. Connect the battery cable connector to the UPS connector. Press firmly to ensure that the connection is tight. You will hear a “snap” when the connector is properly seated.
12. Replace the four (4) screws removed in step 4.
13. Tuck the white battery cable cord neatly into the space above the UPS connector.
14. Hold the front panel bezel with the cutout section on the right. Align the tabs on the side of the bezel with the slots on the front of the UPS ❸ and firmly snap it into place.

Troubleshooting

Use the chart below to solve minor UPS installation problems. Contact APC Technical Support Staff (see *How to Contact APC*, page 4) for assistance with complex UPS problems.

Problem and Possible Cause	Solution
<p>UPS will not turn on.</p> <ul style="list-style-type: none"> • ON button not pushed. • UPS not connected to AC power supply. • UPS's input circuit breaker tripped. • Very low or no utility voltage. • Battery not connected properly. 	<p>Press the ON button once to power the UPS and the connected equipment.</p> <p>Check that the power cable from the UPS to the utility power supply is securely connected at both ends.</p> <p>Reduce the load on the UPS by unplugging equipment and reset the circuit breaker (on back of UPS) by pressing the plunger back in.</p> <p>Check the AC power supply to the UPS with a table lamp. If very dim, have the utility voltage checked.</p> <p>Check that the battery connector is fully engaged.</p>
<p>UPS will not turn off.</p> <ul style="list-style-type: none"> • Internal UPS fault. 	<p>Do not attempt to use the UPS. Unplug the UPS and have it serviced immediately.</p>
<p>UPS operates on-battery although normal line voltage exists.</p> <ul style="list-style-type: none"> • UPS's input circuit breaker tripped. • Very high, low, or distorted line voltage. Inexpensive fuel powered generators can distort the voltage. 	<p>Reduce the load on the UPS by unplugging equipment and reset the circuit breaker (on back of UPS) by pressing the plunger back in.</p> <p>Move the UPS to a different outlet on a different circuit. Test the input voltage with the utility voltage display. If acceptable to the connected equipment, reduce the UPS's sensitivity. See <i>Voltage Sensitivity</i>, page 14, for procedures.</p>
<p>UPS beeps occasionally.</p> <ul style="list-style-type: none"> • Normal UPS operation. 	<p>None. The UPS is protecting the connected equipment.</p>
<p>UPS does not provide expected backup time.</p> <ul style="list-style-type: none"> • The UPS's battery is weak due to a recent outage or is near the end of its service life. • The UPS is overloaded. 	<p>Charge the battery. Batteries require recharging after extended outages. Also, they wear faster when put into service often or when operated at elevated temperatures. If the battery is near the end of its service life, consider replacing the battery even if the replace battery indicator is not yet lit.</p> <p>Check the UPS's load bar display. Unplug less needed equipment, such as printers.</p>
<p>Front panel indicators (the six in the center) light sequentially.</p> <ul style="list-style-type: none"> • The UPS has been shut down by remote control. • The UPS has been put into sleep mode by remote control. 	<p>None. The UPS will restart automatically when utility power returns. The indicators illuminate from top to bottom then bottom to top.</p> <p>None. The UPS will restart automatically when the sleep timer expires. The indicators illuminate from top to bottom then back to the top.</p>

Some or all front panel indicators are flashing.	
• Internal UPS fault or battery charger failure.	Do not attempt to use the UPS. Turn the UPS off and have it serviced immediately.
UPS is plugged into wall outlet and only the battery charge bar graph is lit.	
• The UPS is shut down and the battery is discharged from an extended outage.	None. The UPS will return to normal operation when the power is restored and the battery has a sufficient charge.
Replace battery light is lit and the UPS beeps for one minute every five hours.	
• Weak batteries.	Charge the batteries for 24 hours and perform self-test (see <i>Self-Test</i> , page 12) to see if it clears.
• Bad or expired battery.	Replace the batteries. Refer to <i>Replacing the Battery</i> , page 17.
Replace battery light flashes, battery charge bar graph is off, and the UPS beeps continuously.	
• Battery not connected properly.	Check that the battery connector is fully engaged.

Service

If the UPS requires service do not return it to the dealer! Follow these steps:

1. Review the problems discussed in *Troubleshooting*, page 19, to eliminate common problems.
2. Verify that no circuit breakers are tripped – this is the most common UPS problem!
3. If the problem persists, call customer service, refer to *How to Contact APC*, page 4, or visit the APC Internet website (www.apcc.com).
 - Note the model number of the UPS, the serial number, and the date purchased. A technician will ask you to describe the problem and try to solve it over the phone, if possible. If this is not possible the technician will issue a Returned Material Authorization Number (RMA#).
 - If the UPS is under warranty, repairs are free. If not, there is a repair charge.
4. Pack the UPS in its original packaging. If the original packing is not available, ask customer service about obtaining a new set.
 - Pack the UPS properly to avoid damage in transit. Never use Styrofoam beads for packaging. Damage sustained in transit is not covered under warranty.
 - Include a letter with your name, RMA#, address, copy of the sales receipt, description of the trouble, your daytime phone number, and a check (if necessary).
5. Mark the RMA# on the outside of the package.
6. Return the UPS by insured, prepaid carrier to the address given to you by Customer Service.

APPENDIX A: SPECIFICATIONS

	700 VA	1000 VA	1400 VA
Acceptable input voltage	0 – 325 VAC		
On-line input voltage range (configured via software)	160 – 286 VAC		
Output voltage (configured via software)	196 – 253 VAC		
Input Protection	Resettable circuit breaker		
Frequency limits (on-line operation)	47 – 63 Hz		
Transfer time	2 ms typical, 4 ms maximum		
Maximum load	450 W	670 W	950 W
On-battery output voltage	220, 225, 230, or 240 VAC		
On-battery frequency	50 or 60 Hz, ±0.1 Hz, unless synchronized to utility during brownout		
On-battery waveshape	Sine wave		
Protection	Overcurrent and short-circuit protected, latching shutdown on overload		
Noise Filter	Normal and common mode EMI/RFI suppression		
Battery type	Spill proof, maintenance free, sealed lead-acid		
Typical battery life	3-6 years, depending on number of discharge cycles and ambient temperature		
Typical recharge time	3 hours		
Operating temperature	0 to +40 °C (+32 to +104 °F)		
Storage temperature	-15 to +45 °C (+5 to +113 °F)		
Operating and storage relative humidity	0 to 95%, non-condensing		
Operating elevation	0 to +3,000 m (0 to +10,000 ft)		
Storage elevation	0 to +15,000 m (0 to +50,000 ft)		
Electromagnetic immunity	IEC 801-2 level IV, 801-3 level III, 801-4 level IV, 801-5		
Audible noise in dBA at 1 m (3 ft)	<42	<45	<45
Size (H x W x D)	8.53 cm (ear ht 8.70 cm) x 43.2 cm (ear to ear 48.0 cm) x 45.7 cm 3.36 in (ear ht 3.42 in) x 17 in (ear to ear 18.9 in) x 18 in		
Weight - net (shipping)	21.8 (25.1) kg 48 (55.25) lbs.	28.1 (31.4) kg 62 (69.25) lbs.	28.6 (31.9) kg 63 (70.25) lbs.
Safety approvals	GS licensed by VDE to EN 50091-1-1 and 60950		
EMI verification	EN55022 Class A		

Regulatory Agency Approvals



Declaration of Conformity

Declaration of Conformity

Application of Council Directives: 89/336/EEC, 73/23/EEC, 92/31/EEC, 93/68/EEC, 91/157/EEC

Standards to Which Conformity Declared: EN55022, EN50082-1, EN50091-1, EN60950, IEC 950

Manufacturer's Name and Address: American Power Conversion
132 Fairgrounds Road
West Kingston, Rhode Island, 02892, USA
-or-
American Power Conversion (A. P. C.) b. v.
Ballybritt Business Park
Galway, Ireland
-or-
American Power Conversion Phillipines
Second Street
Caivte EPZA
Roserio, Cavite Phillipines

Importer's Name and Address: American Power Conversion (A. P. C.) b. v.
Ballybritt Business Park
Galway, Ireland

Type of Equipment: Uninterruptible Power Supply

Model Numbers: Smart-UPS 700, 1000, 1400

Serial Numbers: X9901 000 0000 — X9999 999 9999
X0001 000 0000 — X0099 999 9999

Years of Manufacture: 1999, 2000

Note: Where X = B, O, W, or D

We, the undersigned, hereby declare that the equipment specified above conforms to the above directives.

<u>Billerica, MA</u>	<u>1/1/99</u>	<u>Stephen A. Lee</u>
Place	Date	Stephen A. Lee, Regulatory Compliance Engineer
<u>Galway, Ireland</u>	<u>1/1/99</u>	<u>Ray S. Ballard</u>
Place	Date	Ray S. Ballard, Managing Director, Europe

APPENDIX B: TRANSPORTING THE UPS

Follow these guidelines if you need to ship the UPS to another location. These guidelines apply whether you are transporting the UPS alone, rack mounted in an equipment cabinet, or installed in a system.



Always DISCONNECT THE BATTERIES before shipping the UPS to avoid damage during transport. (U.S. Federal Regulation *requires* that batteries be disconnected during shipment.) The batteries may remain in the UPS; they do not have to be removed.

This requirement applies whether the UPS is moved indoors or out, alone or installed in an equipment rack or system.



Graphics are not drawn to scale. They are shown for reference only.

The battery compartment is located under the front panel bezel.

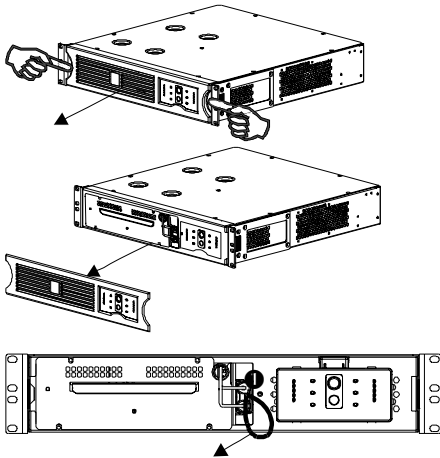

1. Face the front of the UPS and, using both hands, insert each index finger behind the lip of the curved section of the front panel bezel and pull towards you. The front panel bezel will unsnap.
2. Set the bezel aside.
3. Take out the white cord, which is tucked into the space above the battery connector **1**. Grasp the cord and pull firmly towards you to disconnect the battery.



Remember to connect the batteries once the UPS has arrived at its destination.

NOTES